

SECURITY DOORS



INTERNO
DOORS BY ALUMIL

ΠΕΡΙΕΧΟΜΕΝΑ / INDEX

• 04

GLASS

• 08

ALUMINIUM

• 14

WOOD ULTRA

• 20

WOOD

• 26

LAMINATE

• 32

ΤΕΧΝΙΚΑ ΧΑΡΑΚΤΗΡΙΣΤΙΚΑ
TECHNICAL CHARACTERISTICS

• 35

ΤΥΠΟΙ ΘΥΡΩΝ ΑΣΦΑΛΕΙΑΣ
SECURITY DOOR TYPES

• 36

ΕΞΟΠΛΙΣΜΟΣ & ΕΞΑΡΤΗΜΑΤΑ
EQUIPMENT & ACCESSORIES

• 37

ΧΕΡΟΥΛΙΑ-ΜΠΑΡΕΣ / HANDLES-BARS

• 38

ΧΡΩΜΑΤΟΛΟΓΙΟ / COLOR BOOK

OPAMA

Θωρακισμένες Πόρτες Ασφαλείας Interno doors by Alumil

Με αφοσίωση στο σχεδιασμό και την παραγωγή συστημάτων θυρών υψηλής ποιότητας και τεχνολογίας, οι θωρακισμένες πόρτες της Interno ανταποκρίνονται πλήρως στις αυξημένες απαιτήσεις αισθητικής και επιδόσεων, προσφέροντας μέγιστη ασφάλεια και ανθεκτικότητα στη διάρκεια του χρόνου.

Η σειρά διατίθεται σε ποικιλία σχεδίων, χρωμάτων και φινιρισμάτων παρέχοντας πολλαπλές σχεδιαστικές λύσεις. Αποτελεί ιδανική επιλογή για κατοικίες και επαγγελματικούς χώρους παρέχοντας πλήρη θωράκιση, απόλυτη λειτουργικότητα και ευελιξία.

Οι θωρακισμένες πόρτες της Interno εξοπλίζονται με κορυφαίας ποιότητας εξαρτήματα και αξεσουάρ, παρέχοντας επιπλέον δυνατότητες παραμετροποίησης και προσωποποίησης των αναγκών του εκάστοτε χώρου.

VISION

Security Doors Interno by Alumil

With devotion in design and production of high quality and technology doors, Interno Security Doors correspond fully to the increased aesthetic and performance demands, offering maximum security and durability.

The series is available in a variety of designs, colors and surface finishing options, allowing for versatility and multiple design solutions. The series constitutes an ideal selection for both residential and commercial spaces, providing absolute security and functionality.

Interno Security Doors are equipped with top quality accessories, allowing for additional customization and individualization of the parameters of each space.



INTERNO

DOORS BY ALUMIL

GLASS

Μοντέρνες και λιτές γραμμές αντανακλώνται σε πληθώρα επιλογών υάλινων επενδύσεων και σχεδίων, παρέχοντας τη δυνατότητα χρωματισμού της θύρας σε οποιοδήποτε RAL κωδικό.

Modern and pure lines may be reflected in numerous glass finishes and designs, providing freedom in selecting any RAL color.

CODE # GL4



επένδυση • finish

- Τζάμι Ral 9007 / Glass Ral 9007

κάσα • frame

- Αλουμίνιο φυσική ανοδίζωση
Natural anodizing aluminium

σταθερό • fixed sash

- Τζάμια διάφανα ασφαλείας (26mm)
Transparent security glass (26mm)

κάγκελο • rail

- INOX οριζόντιες βέργες
INOX horizontal bar railing





GL2



GL4



επένδυση • finish

- Τζάμι Ral 9005 / Glass Ral 9005

φάσα • sash

- Φυσική ανοδίζωση αλουμινίου / Natural anodizing aluminium

κάσα • frame

- Φυσική ανοδίζωση αλουμινίου / Natural anodizing aluminium



επένδυση • finish

- Τζάμι Ral 9016 λευκό / Glass Ral 9016 white

φάσα • sash

- Φυσική ανοδίζωση αλουμινίου / Natural anodizing aluminium

κάσα • frame

- Φυσική ανοδίζωση αλουμινίου / Natural anodizing aluminium

GL4**GL3****επένδυση • finish**

- Τζάμι Ral 3020 / Glass Ral 3020

φάσα • sash

- Φυσική ανοδίωση αλουμινίου / Natural anodizing aluminium

κάσα • frame

- Φυσική ανοδίωση αλουμινίου / Natural anodizing aluminium

**επένδυση • finish**

- Τζάμι Ral 1013 / Glass Ral 1013

φάσα • sash

- Φυσική ανοδίωση αλουμινίου / Natural anodizing aluminium

κάσα • frame

- Φυσική ανοδίωση αλουμινίου / Natural anodizing aluminium

ALUMINIUM

Η αντοχή στο χρόνο και σε δυσμενείς καιρικές συνθήκες, επιβάλλει την υιοθέτηση επενδύσεων αλουμινίου για την εξωτερική όψη της θύρας. Η ποικιλία σχεδίων και χρωματικών συνδυασμών που προσφέρονται, εξασφαλίζει την ικανοποίηση των εκάστοτε αισθητικών αναγκών με αδιαπραγμάτευτη λειτουργικότητα και επιδόσεις.

Durability in time and adverse weather conditions, enforce the adoption of aluminium surface finishes externally. The variety of designs and color options available, ensure the satisfaction of any individual aesthetic needs with uncompromising functionality and performances in time.

CODE # SEC3640



επένδυση • finish

- Sable 2900 Gris αλουμίνιο
Sable 2900 Gris aluminium

κάσα • frame

- Sable 2900 Gris αλουμίνιο
Sable 2900 Gris aluminium

σταθερό • fixed sash

- Τζάμι αμμοβολή ασφαλείας 26mm
Sandblasted security glass 26mm

κάγκελο • rail

- Μαύρο χιαστί
Black cross wise rails





SEC4515

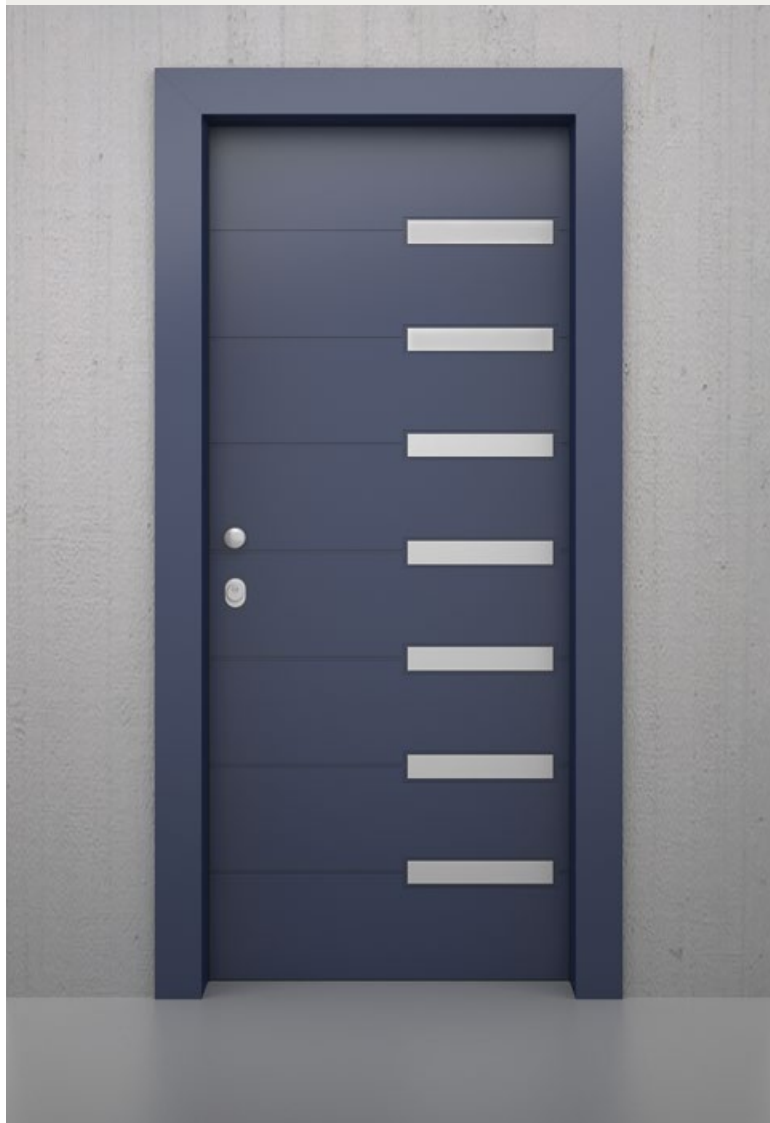

επένδυση • finish

- Sable 2700 BLEU αλουμινίου / aluminium

κάσα • frame

- Sable 2700 BLEU αλουμινίου / aluminium

SEC3580

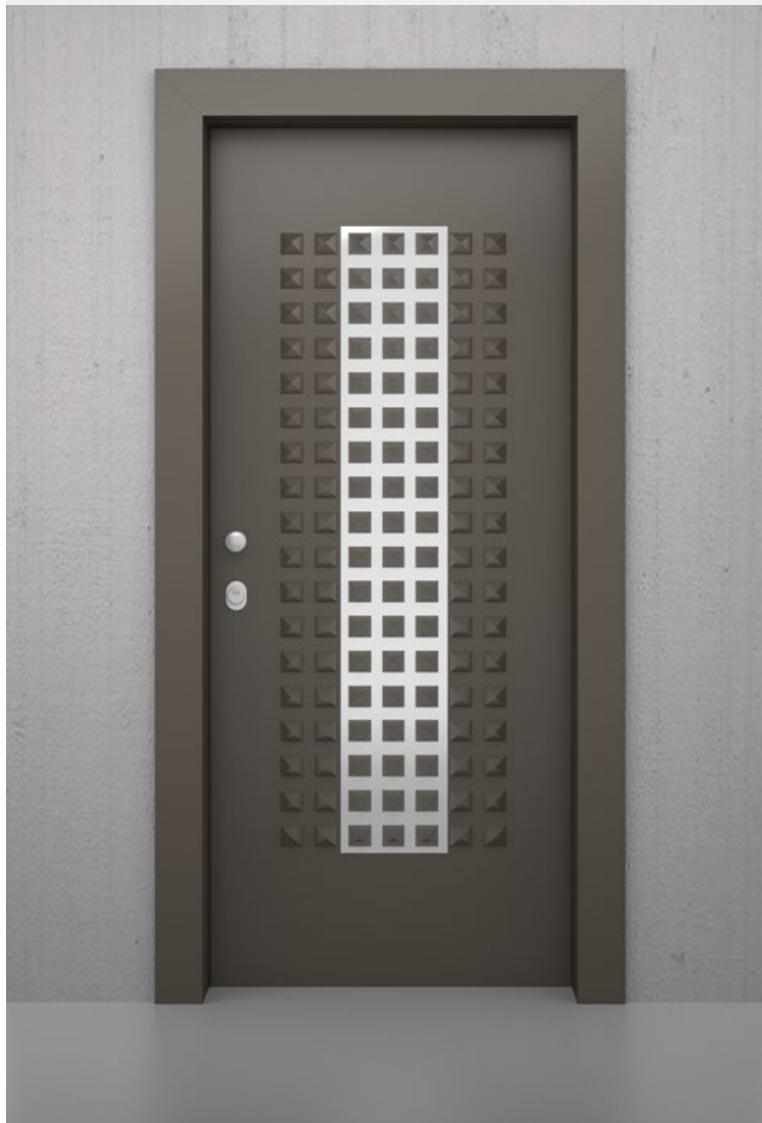

επένδυση • finish

- Sable 2500 VERT αλουμινίου / aluminium

κάσα • frame

- Sable 2500 VERT αλουμινίου / aluminium

SEC5045**επένδυση • finish**

- Σουμπληρωμία χρυσός δρύς 1335 αλουμινίου
Sublimation gold oak 1335 aluminium

κάσα • frame

- Σουμπληρωμία χρυσός δρύς 1335 αλουμινίου
Sublimation gold oak 1335 aluminium

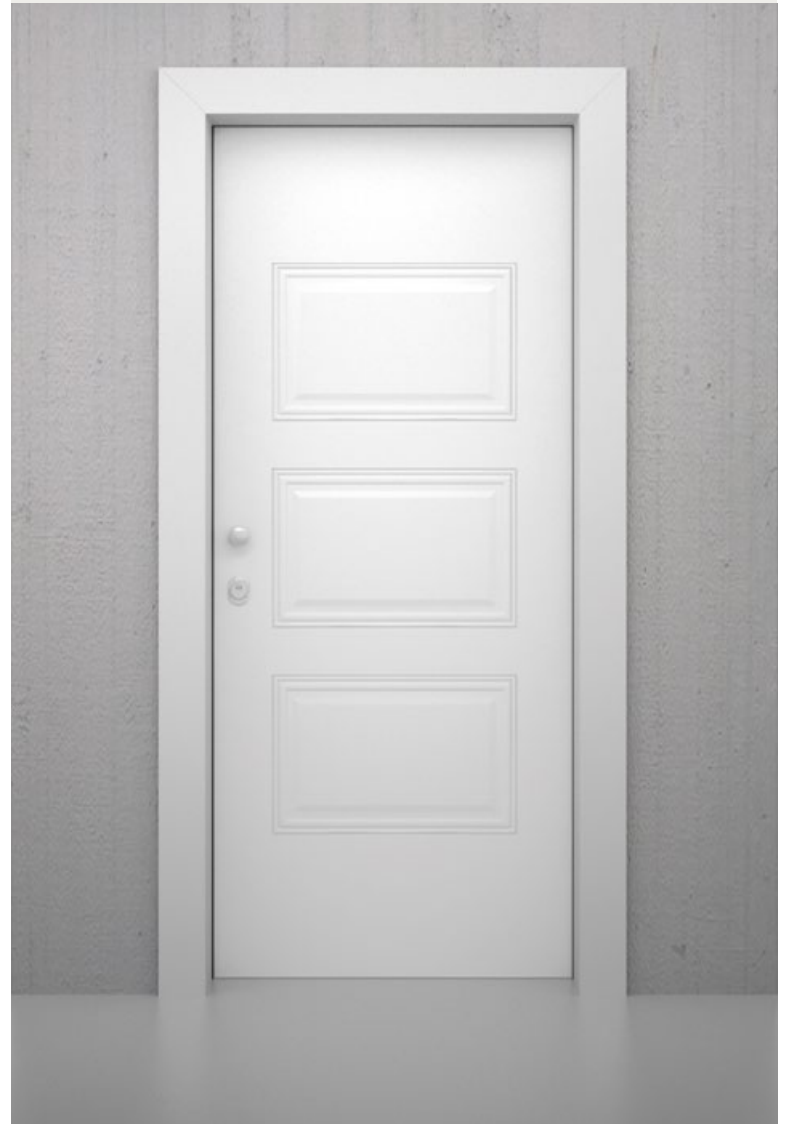
SEC3550**επένδυση • finish**

- Λευκό αλουμινίου / White aluminium

κάσα • frame

- Λευκό αλουμινίου / White aluminium

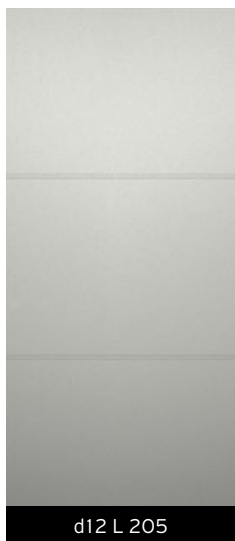

d12 L 205



d13 L 215



d2 L 240

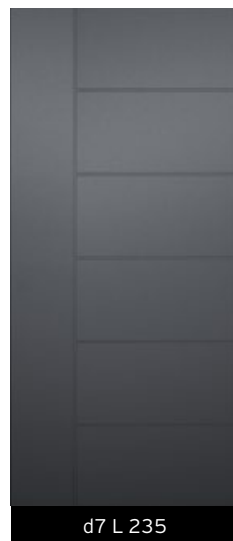

d7 L 235

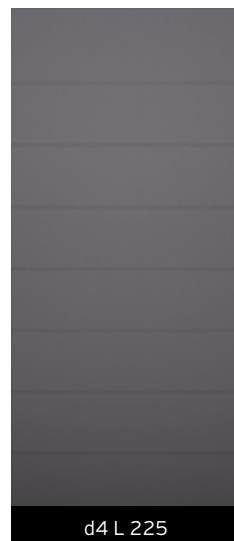

d4 L 225

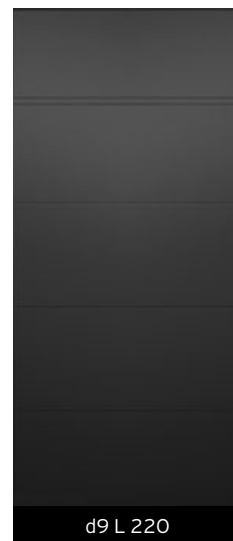

d9 L 220

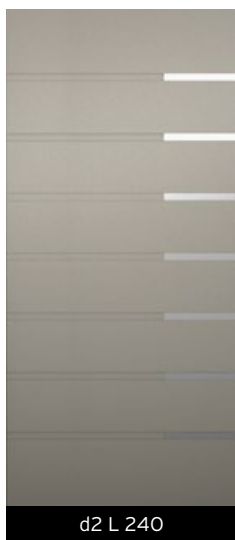

d2 L 240

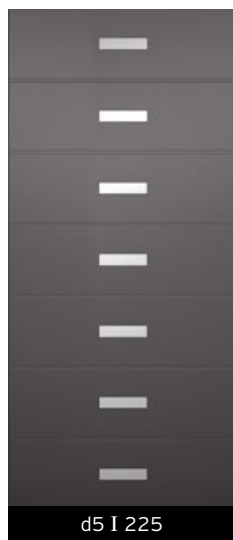

d5 I 225



d19 I 210



d11 I 215



d3 L 210



d8 L 245



d15 I 245



d16 I 250

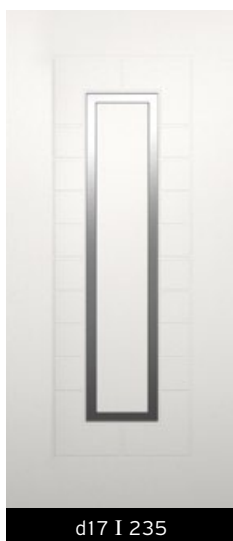

d17 I 235



d6 I 205



d14 I 220



d10 L 230

ΚΛΑΣΙΚΑ / CLASSIC

Λαμαρίνα 1mm / Sheet metal 1mm

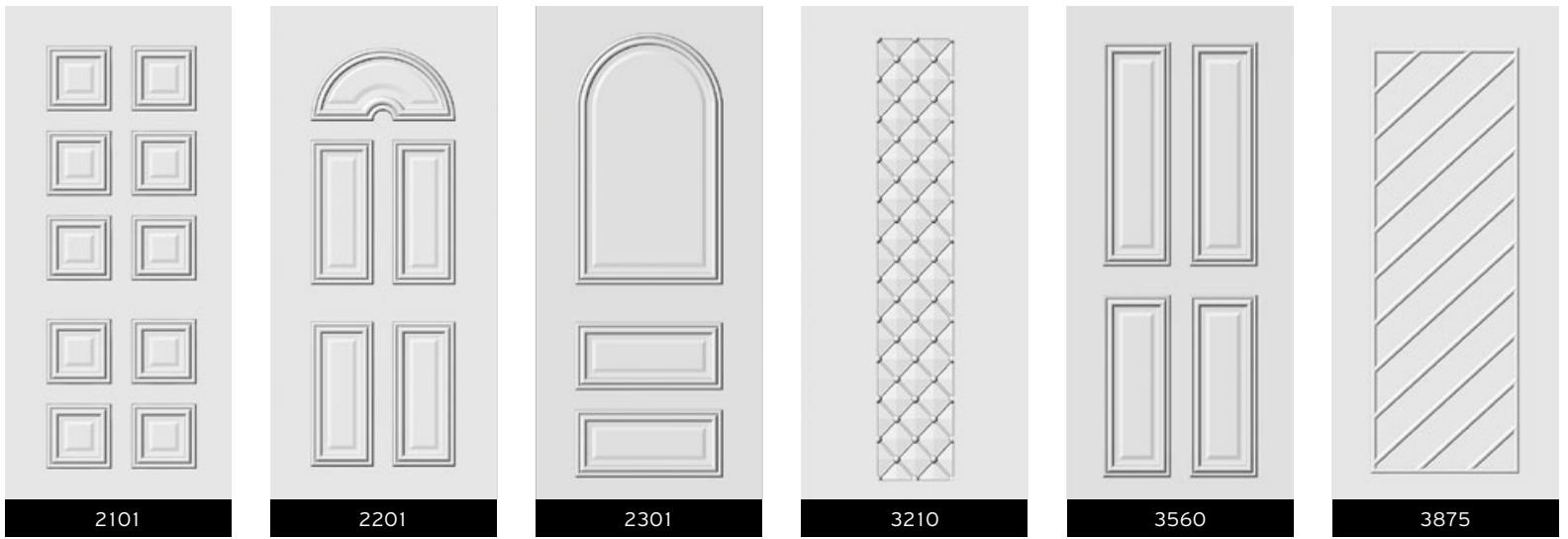

INOX

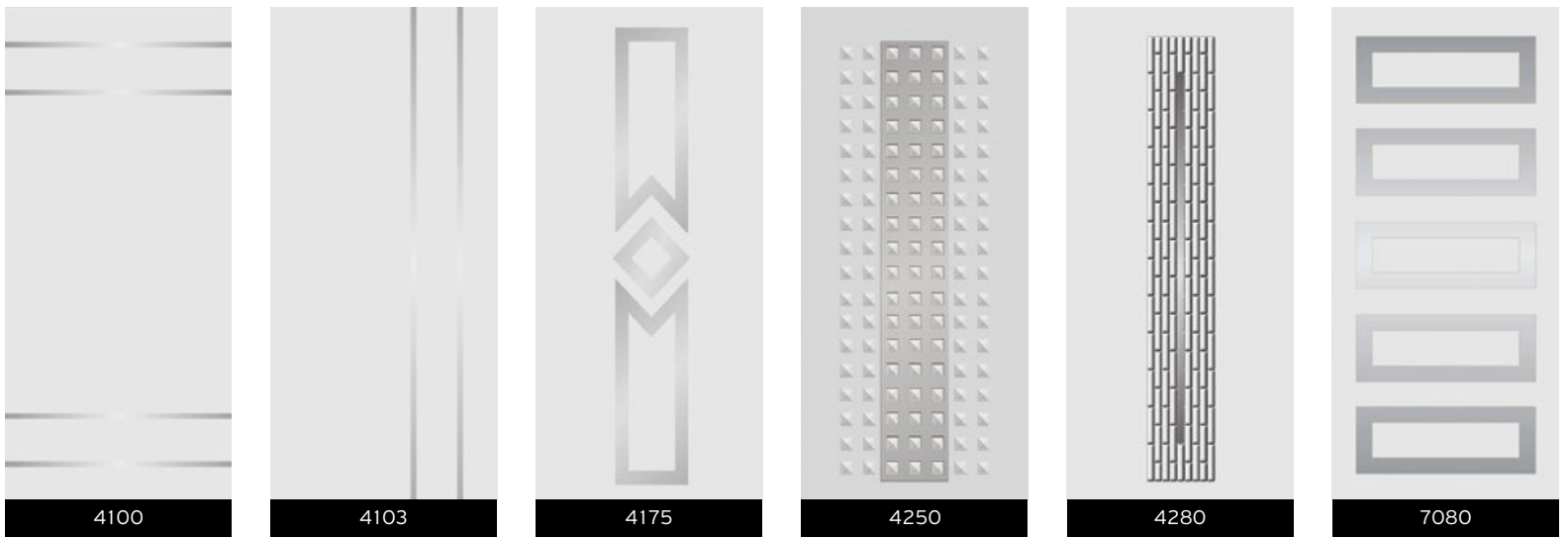

ΠΑΡΑΔΟΣΙΑΚΑ / TRADITIONAL



WOOD ULTRA

Λάτρεις του ξύλου τόσο σε κλασικές όσο και σε μοντέρνες γραμμές. Η κατηγορία Wood Art, παρέχει πλήθος επιλογών φυσικών ξύλινων επενδύσεων και χρωμάτων, σε χειροποίητα και marqueterie σχέδια, προσφέροντας τη ζεστασιά – διαχρονικότητα του ξύλου για ποικίλες ανάγκες διακόσμησης.

Are you Enthusiasts of wood in classic and modern lines. The Wood Art category provides numerous options in natural wooden finishes and colors, in both handmade and marqueterie designs, offering temporal warmth for diverse decorative needs.

CODE # 2-A51



επένδυση • finish

- Ανίγρε, χρώμα καρυδί
Aniegre in walnut coloring

κάσα • frame

- Ανίγρε, χρώμα καρυδί
Aniegre in walnut coloring





DIAS



επένδυση • finish

- Καρυδιά & Ρίζα καρυδιάς / Walnut & Walnut root

κάσα • frame

- Καρυδιά / Walnut

ALINA

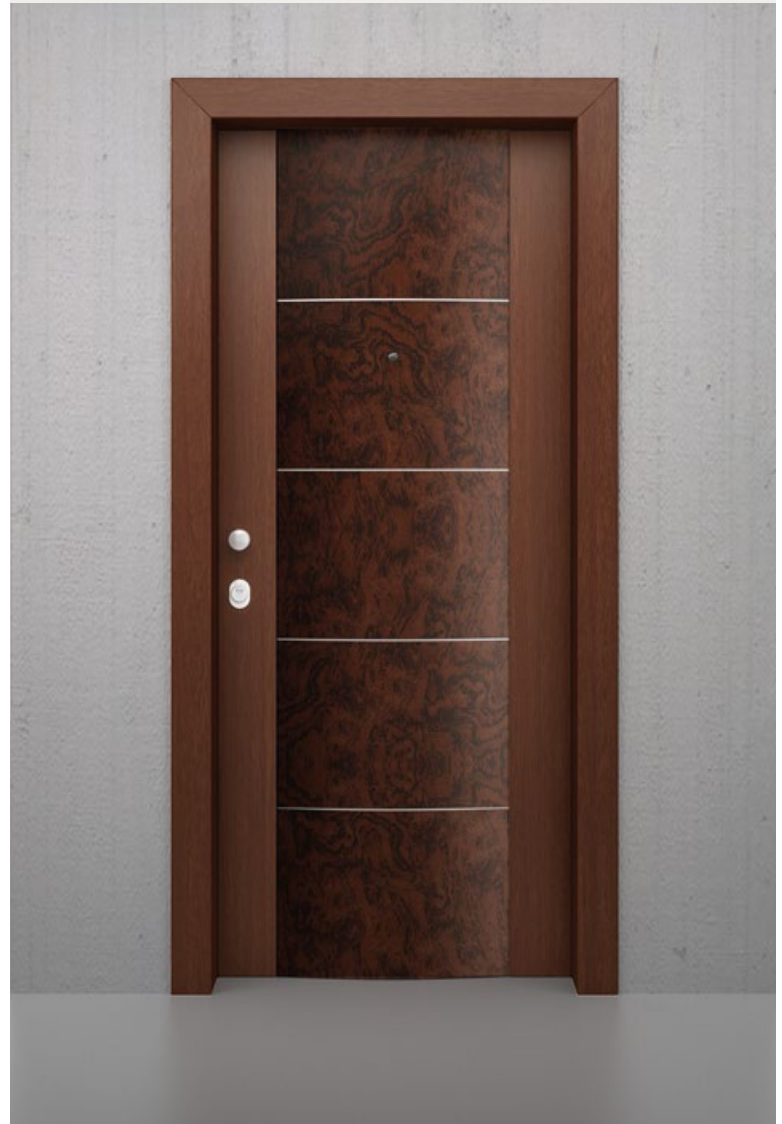

επένδυση • finish

- Ανιγρέ & Ρίζα τριανταφυλιάς / Aniegre & Rosewood Root

κάσα • frame

- Ανιγρέ / Aniegre

LA PAZ



επένδυση • finish

- Δρυς φυσικό & Wenge / Natural oak & Wenge

κάσα • frame

- Δρυς φυσικό / Natural oak

ZURICH

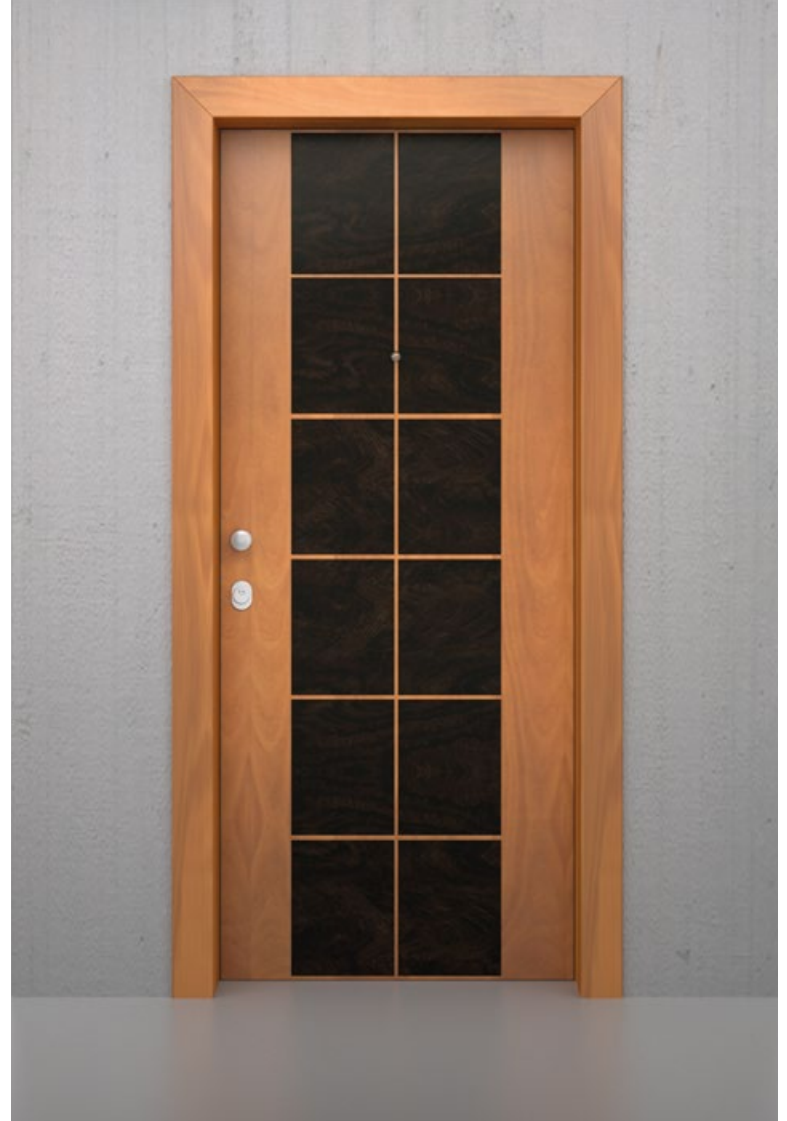

επένδυση • finish

- Οξιιά & Ρίζα καρυδιάς / Beech & Rosewood Root

κάσα • frame

- Οξιιά / Beech

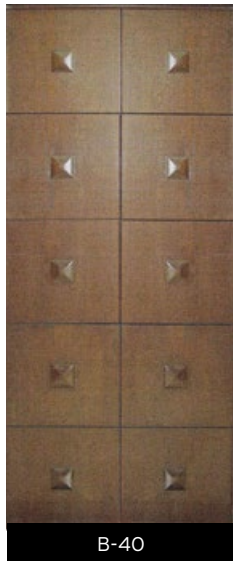
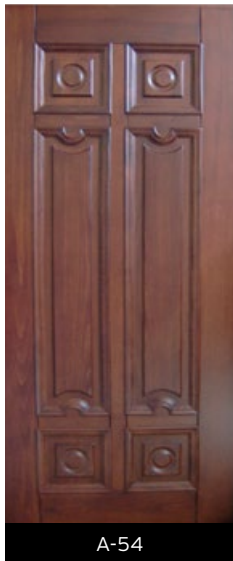
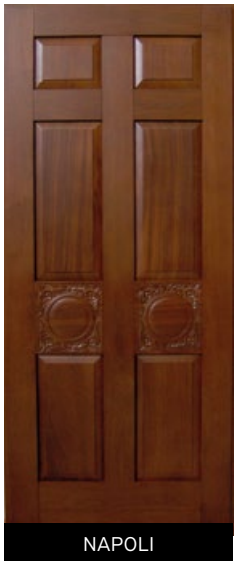

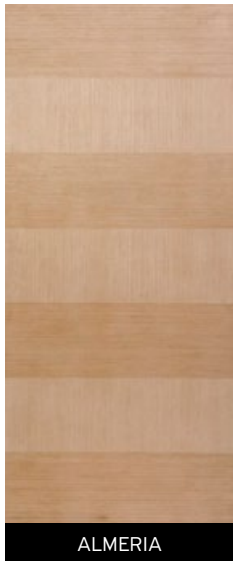

ALMERIA

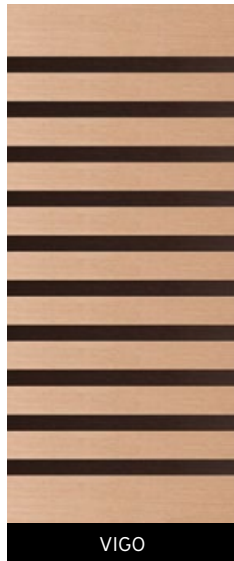

VIGO



PALMA



TOLEDO



BREST



ROTTERDAM

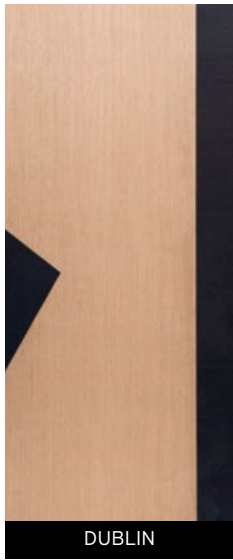

DUBLIN

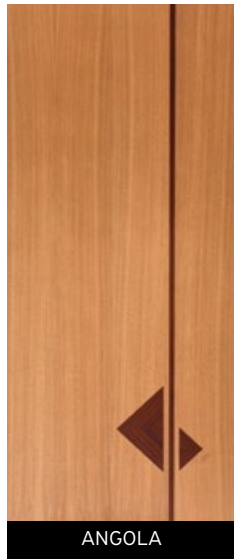

ANGOLA

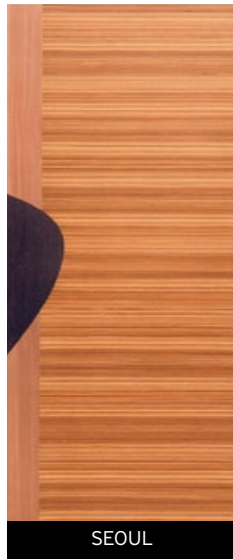

SEOUL

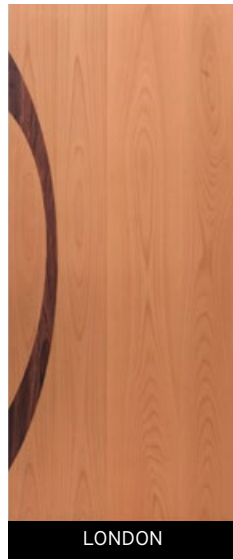

LONDON

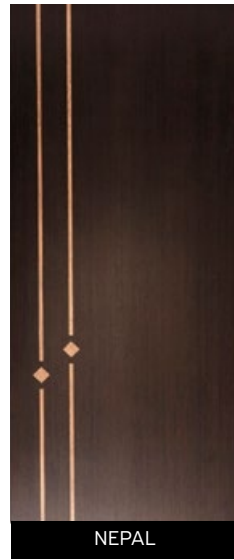

NEPAL

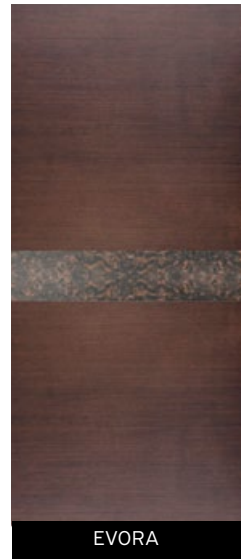

EVORA

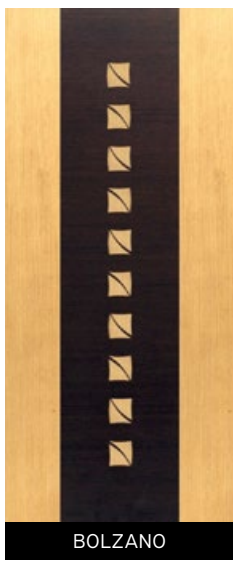

BOLZANO

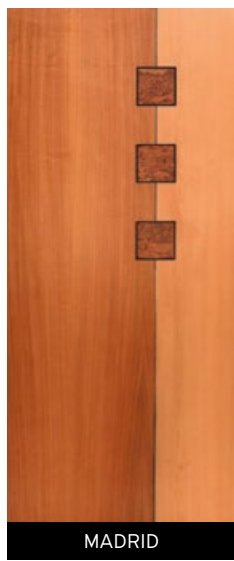

MADRID

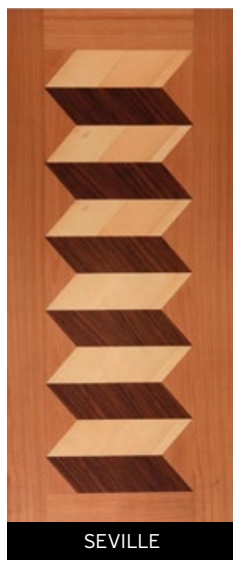

SEVILLE



ZURICH



COPENHAGEN



ZEBRA

WOOD

Καθαρές γραμμές ξύλου σε ποικιλία φυσικών καπλαμάδων, αλλά και επενδύσεων λάκας, με δυνατότητα περαιτέρω παραμετροποίησης με παντογραφικά σχέδια. Η κατηγορία WOOD προσφέρει ευελιξία και δυνατότητες προσωποποίησης των αναγκών σας.

Pure wooden lines in a variety of natural veneers and lacquer finishes, allow for further parameterization with engravings and pantographic designs. WOOD category offers flexibility and possibilities of customization, according to your needs.

CODE # ΔΡΥΣ FT01/OAK FT01



επένδυση • finish

- Δρύς, χρώμα FT102
Oak color FT102

κάσα • frame

- Δρύς, χρώμα FT102
Oak color FT102





**ΔΡΥΣ FT07
OAK FT07**



επένδυση • finish

- Δρύς, χρώμα FT104 / Oak color FT104

κάσα • frame

- Δρύς, χρώμα FT104 / Oak color FT104

RAFLES



επένδυση • finish

- Μαύρο δέρμα λάκα, τριανταφυλλιά gloss
Lacquer black leather rosewood gloss

κάσα • frame

- Μαύρο δέρμα λάκα / Black leather lacquer

ANIGRE 325

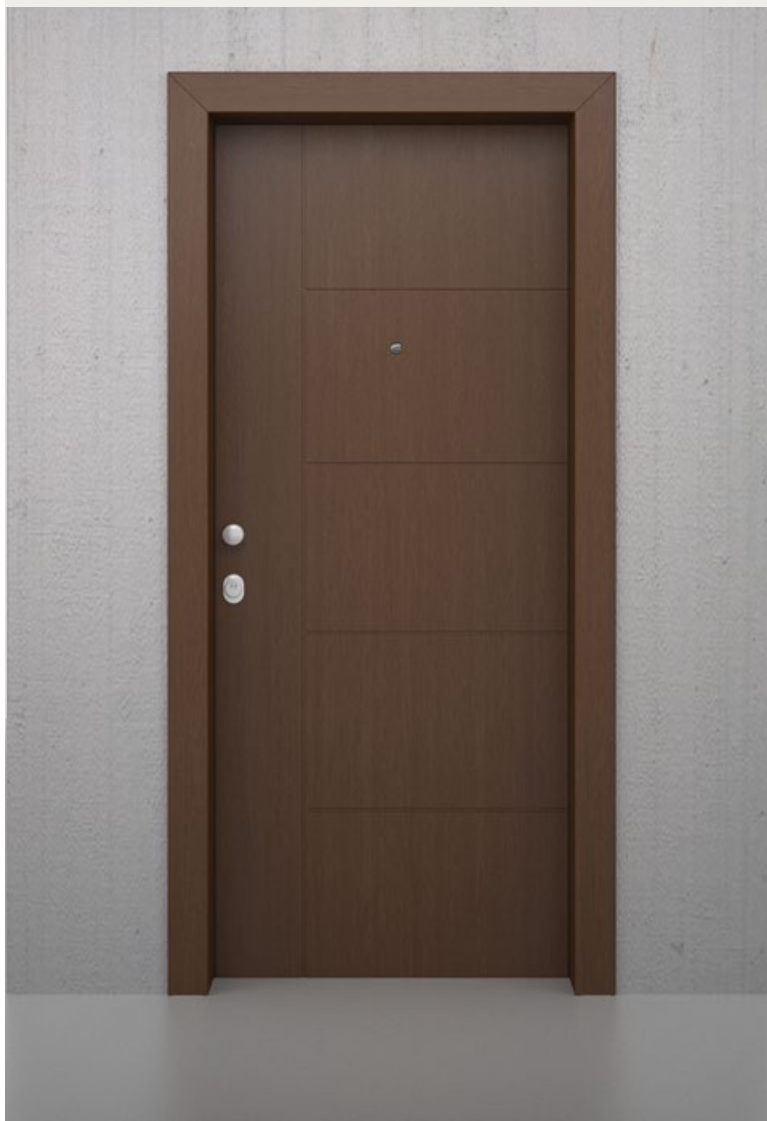

επένδυση • finish

- Anigre, χρώμα καρυδί / Aniegre in walnut color

κάσα • frame

- Anigre, χρώμα καρυδί / Aniegre in walnut color

ΛΑΚΑ FT06 LACQUER FT06

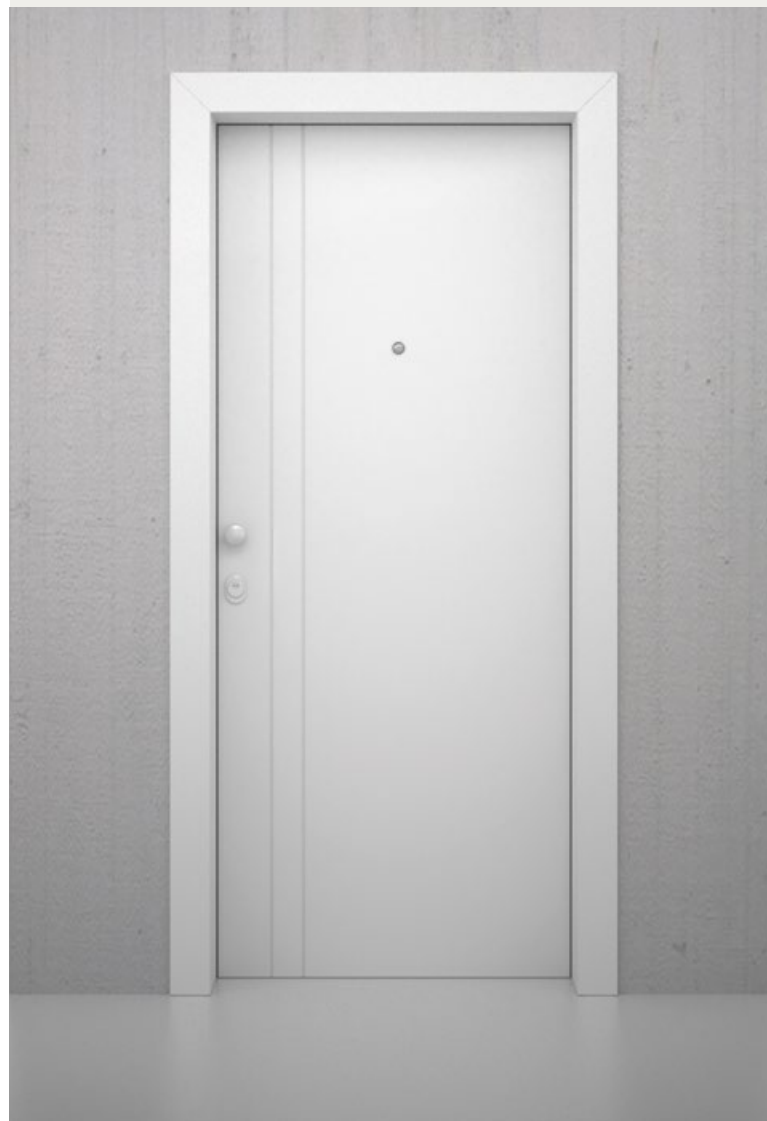

επένδυση • finish

- Λάκα λευκή / Lacquer white

κάσα • frame

- Λάκα λευκή / Lacquer white

Δρυς / Oak



Παντογραφικά / Pantographic

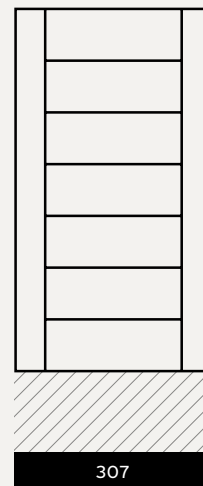
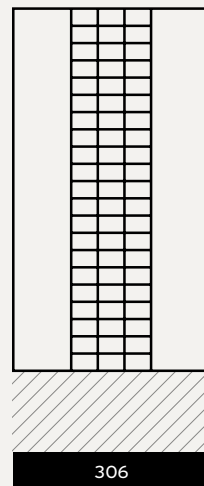
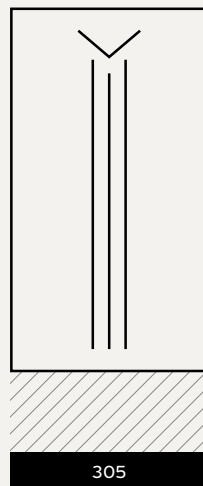
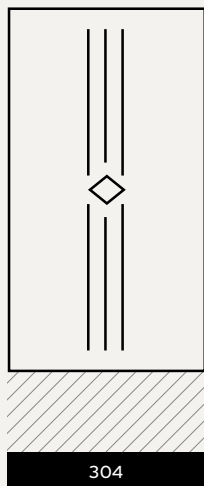
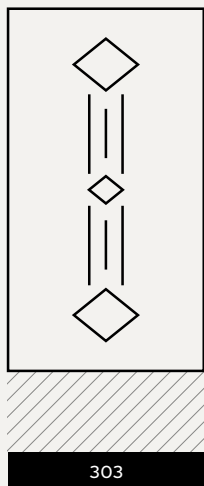
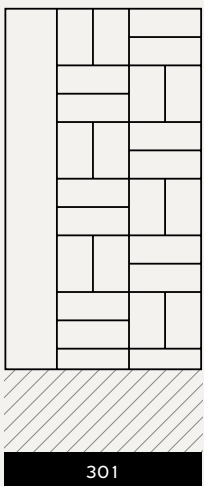
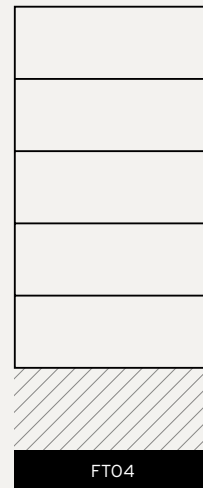
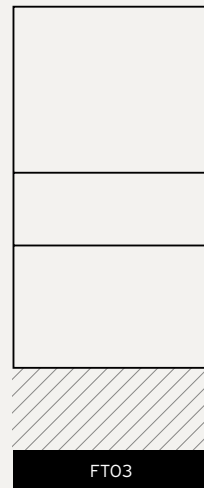
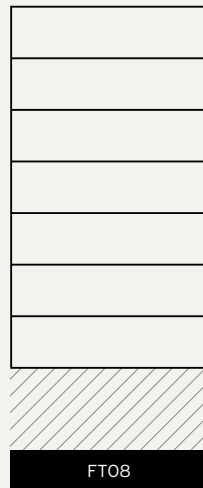
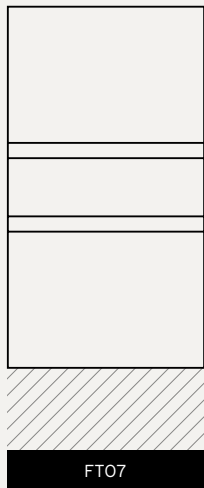
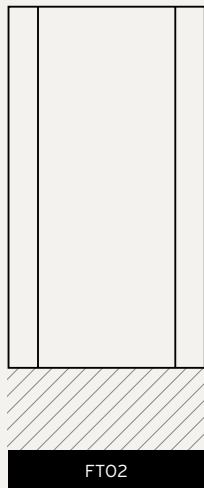
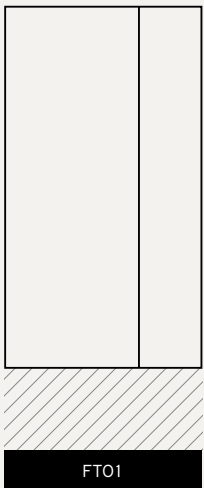

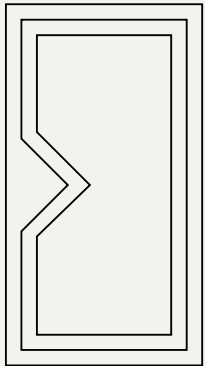

309

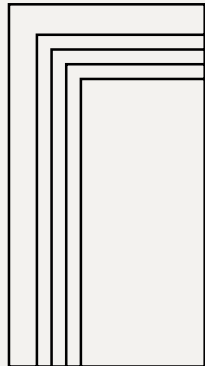

311

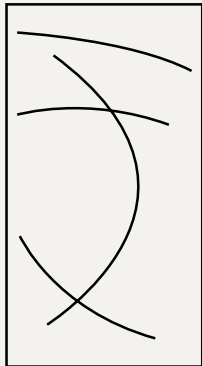

315

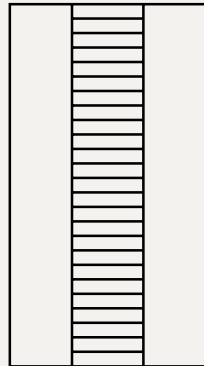

323

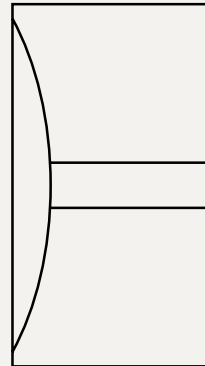

331

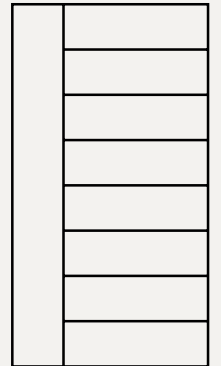

334

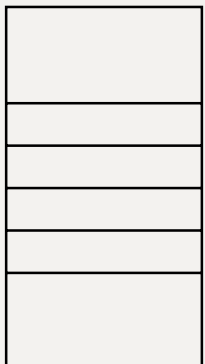

339

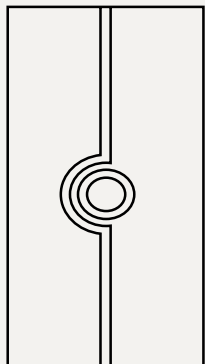

341

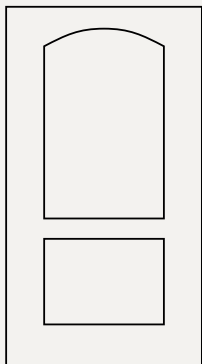

402

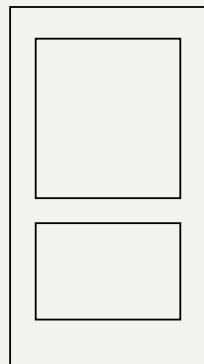

405

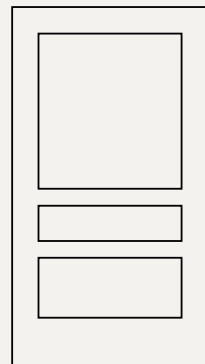

411

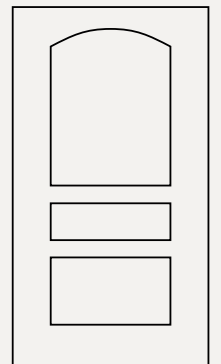

412

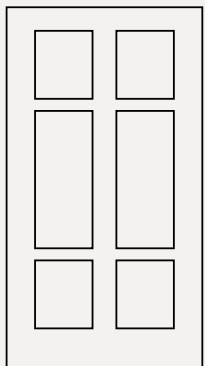

414

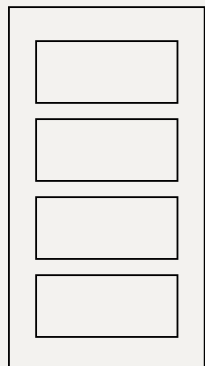

419

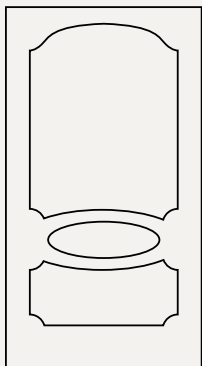

420

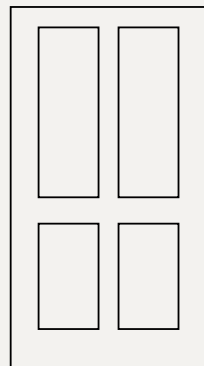

422

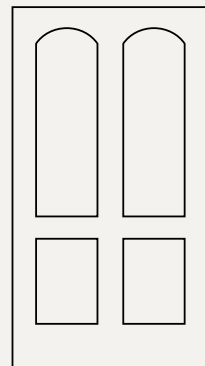

425

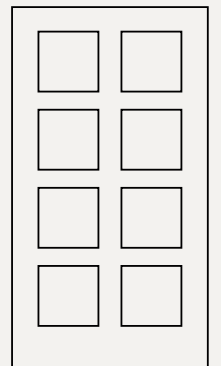

508

INTERNO

DOORS BY ALUMIL

LAMINATE

Η κατηγορία LAMINATE διαθέτει σύγχρονα υλικά υψηλής αισθητικής σε ιδιαίτερα ανταγωνιστικές τιμές. Οι θύρες με επενδύσεις laminate ενδείκνυνται για χρήση σε εσωτερικό χώρο και προσφέρουν ποικιλία χρωμάτων και διακοσμήσεων σε μοντέρνες γραμμές

The LAMINATE category features modern and high aesthetic materials at highly competitive prices. Laminate finishes are suitable for adoption in interior spaces, providing also a variety of colors and decorative elements in modern lines.

CODE # 207 ΑΛΟΥΜΙΝΙΟ ΑΝΟΔΙΩΣΗ ANODIZING ALUMINIUM



επένδυση • finish

- Laminate LK65

κάσα • frame

- Laminate LK65





LM01



LM02



επένδυση • finish

- Laminate δρυς wenge / Laminate oak wenge

κάσα • frame

- Laminate δρυς wenge / Laminate oak wenge

φάσα • sash

- Φυσική ανοδίωση αλουμινίου / Natural anodizing aluminium



επένδυση • finish

- Laminate LK65

κάσα • frame

- Laminate LK65

φάσα • sash

- Φυσική ανοδίωση αλουμινίου / Natural anodizing aluminium

206 ΑΛΟΥΜΙΝΙΟ ΑΝΟΔΙΩΣΗ
206 ANODIZING ALUMINIUM



201 ΑΛΟΥΜΙΝΙΟ ΑΝΟΔΙΩΣΗ
201 ANODIZING ALUMINIUM

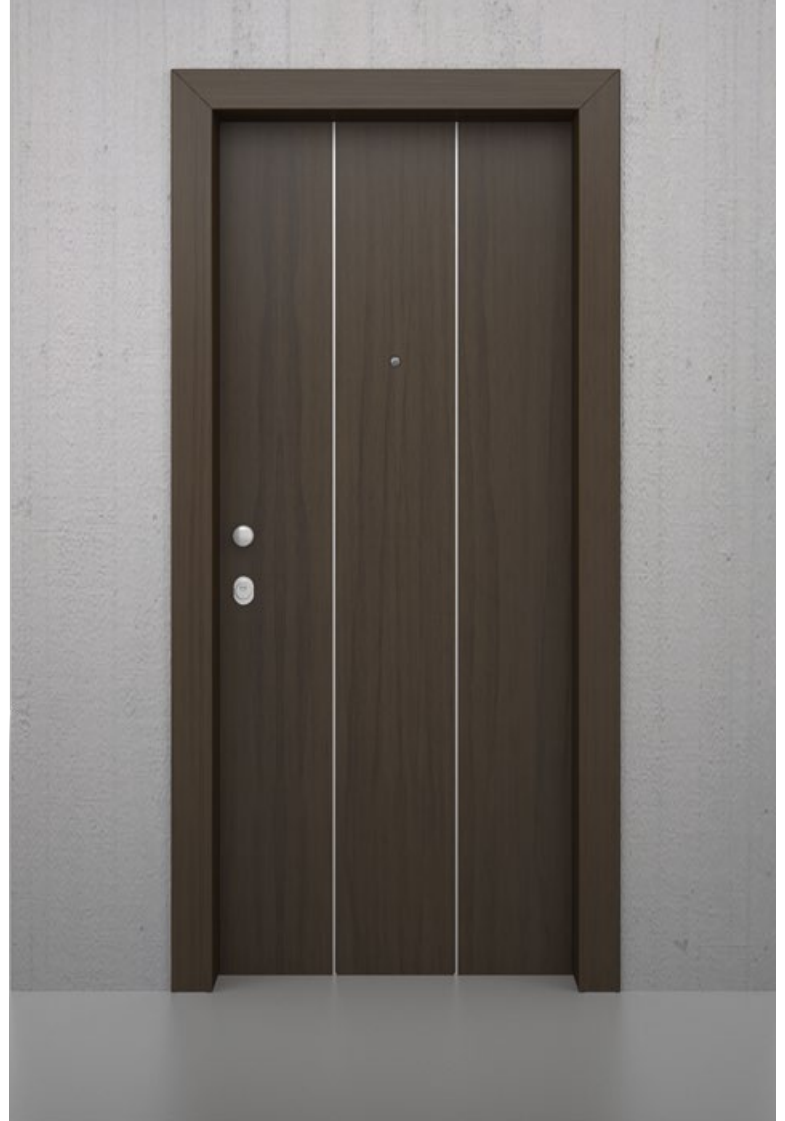

επένδυση • finish

- Laminate δρυς ανοιχτό οριζόντια νερά / Laminate light oak horizontal waves

κάσα • frame

- Laminate δρυς ανοιχτό / Laminate light oak



επένδυση • finish

- Laminate καρυδιά / Laminate walnut

κάσα • frame

- Laminate καρυδιά / Laminate walnut

Σχέδια με διακοσμητικά στοιχεία αλουμίνιο ανοδίζση / Designs with aluminium anodizing decorating elements

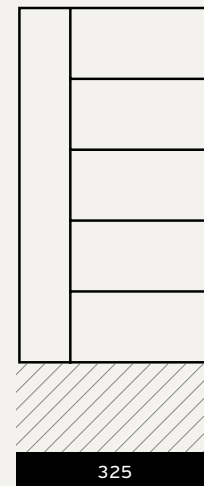
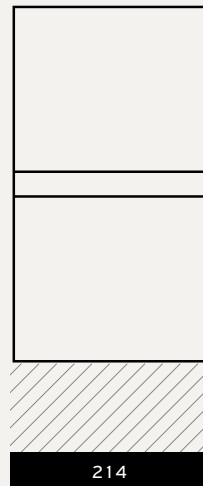
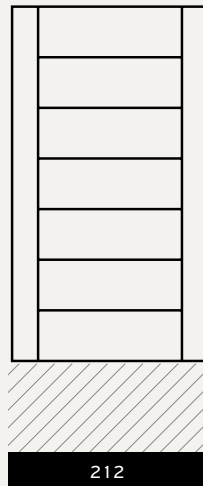
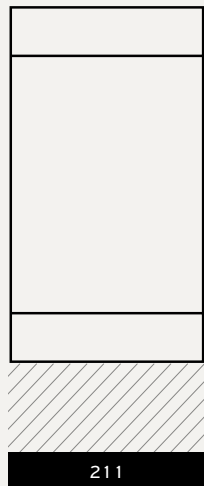
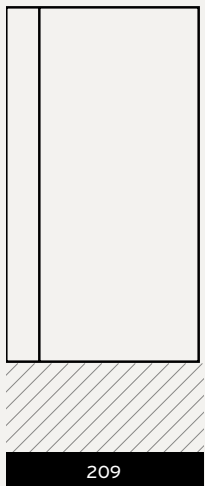
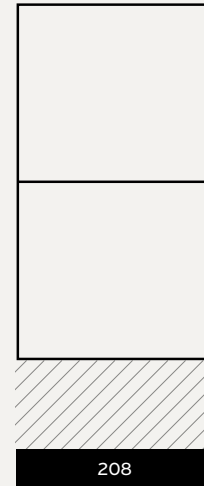
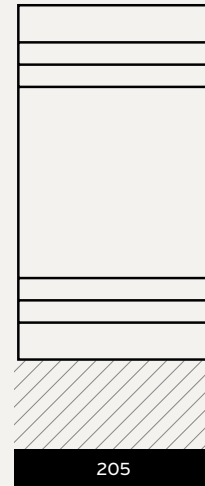
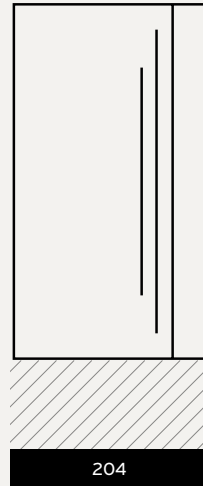
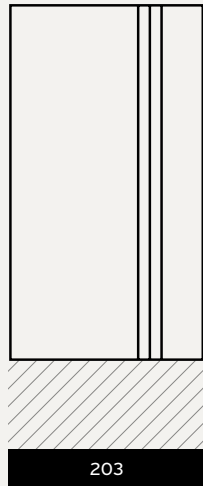
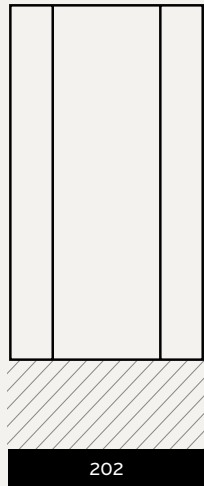

Χρώματα laminate / Laminate colors

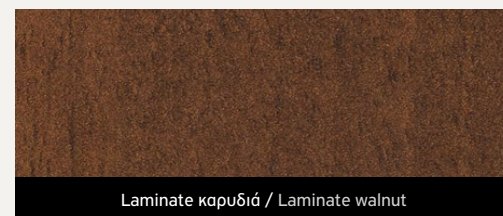
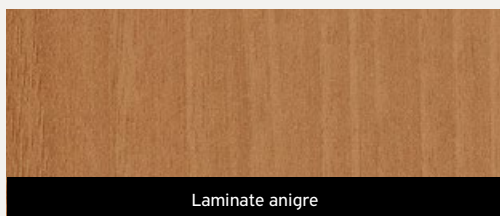

ΕΞΟΠΛΙΣΜΟΣ ACCESSORIZE

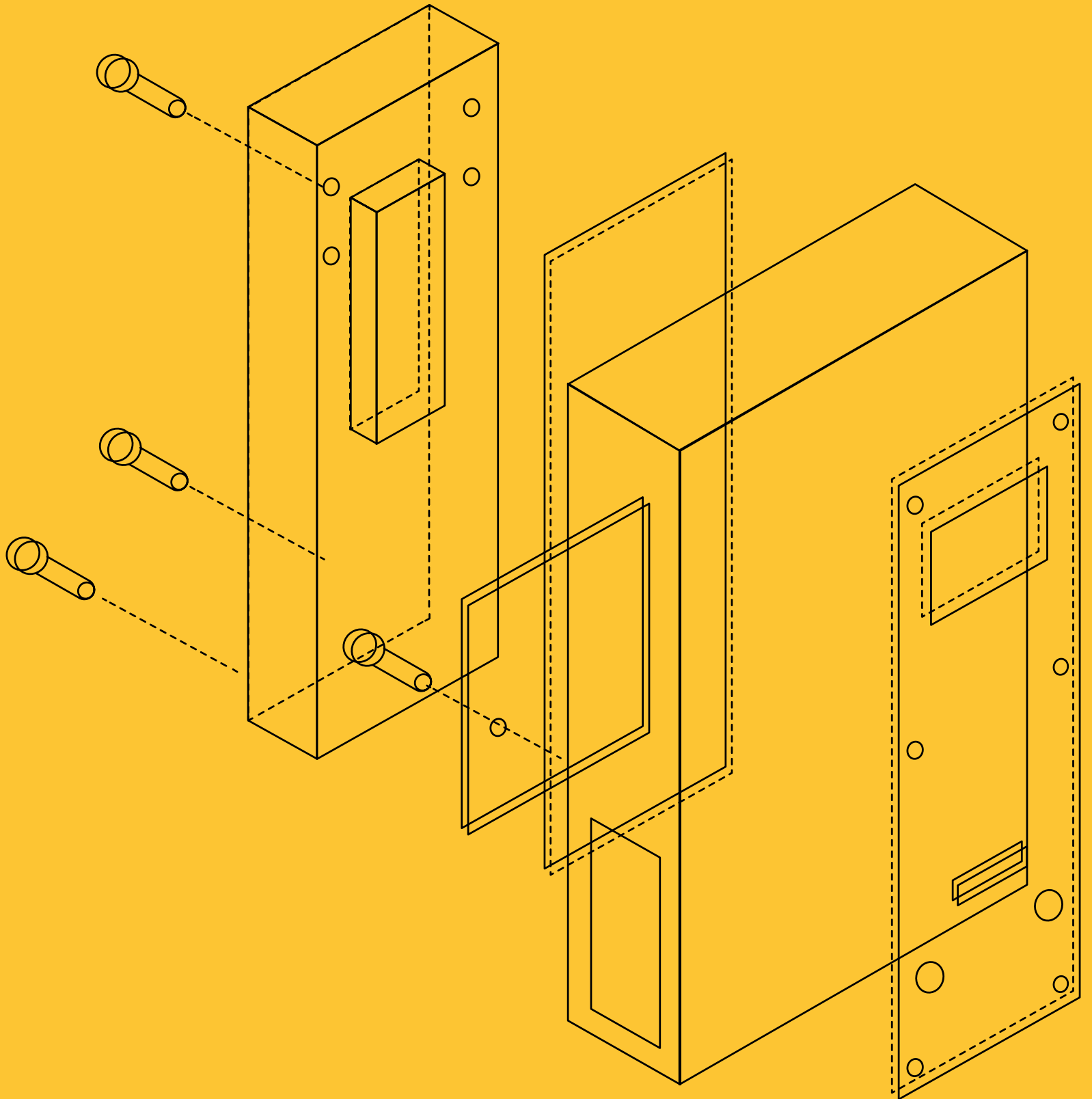

ΣΤΑΝΤΑΡ ΕΞΟΠΛΙΣΜΟΣ
STANDART EQUIPMENT

| | ECONOMY DOOR | ECONOMY DOOR PLUS | S13XL | S16XL | S20XL |
|--|---------------------|--------------------------|--------------|--------------|--------------|
| Σημεία κλειδώματος Locking points | 12 | 18 | 13 | 16 | 20 |
| Κλειδαριά μικρό κλειδί SECUREME-SECURTINA Compact key SECUREME-SECURTINA lock | • | - | - | - | - |
| Κλειδαριά μικρό κλειδί SECUREME γραναζωτή Compact key-SECUREME gear lock | - | • | • | • | • |
| Κύλινδρος K2 SECUREME K2 SECUREME Cylinder | • | • | • | • | • |
| Λάστιχο κάσας Frame gasket | • | • | • | • | • |
| Λάστιχο φύλλου Leaf gasket | - | - | • | • | • |
| Ρεγουλατόρος γλώσσας Latch bolt regulator | • | • | - | - | - |
| Ρεγουλατόρος γλώσσας βαρέως τύπου Heavy duty latch bolt regulator | - | - | • | • | • |
| Μόνωση (πετροβάμβακα) Stonewool insulation seal | - | - | - | • | • |
| Πρόσθετη κάθετη μπάρα ενίσχυσης, λαμαρίνας 1,25mm Additional vertical reinforcement bars with steel sheets 1,25mm | - | - | - | • | • |
| Ανεμοφράκτης Windbreak | • | • | • | • | • |
| Μεντεσέδες ρυθμιζόμενοι σε ύψος και πλάτος Adjustable Hinges in height and width | • | • | • | • | • |
| Διακοσμητικά κασώματα μέσα έξω Frame decoratives inside-outside | • | • | • | • | • |
| Λαβή, Πόμολο, Μπλοκ Ασφαλείας Ροζέτες μέσα - έξω, Ματάκι Fixed Handle, Handle, Semi-clozing latch, Rosettes inside- outside, Spy hole | • | • | • | • | • |

ΔΙΑΣΤΑΣΙΟΛΟΓΙΟ
DIMENSIONS

| | | | | | |
|----------------|---------------|---------------|----------|---|---|
| Ύψος / Height | 205, 211, 216 | 205, 211, 216 | 211, 216 | - | - |
| Πλάτος / Width | 90, 96, 102 | 90, 96, 102 | 97, 102 | - | - |

ΕΠΙΠΛΕΟΝ ΕΞΟΠΛΙΣΜΟΣ ADDITIONAL EQUIPMENT

| | ECONOMY DOOR | ECONOMY DOOR PLUS | S13XL | S16XL | S20XL |
|--|-----------------|----------------------|-------|-------|-------|
| Κλειδαριά μικρό κλειδί FIAM-ISEO γραναζωτή Compact key-FIAM-ISEO gear lock | - | - | • | • | • |
| Κύλινδρος R7 FIAM-ISEO R7 FIAM-ISEO cylinder | • | • | • | • | • |
| Κύλινδρος R50 FIAM-ISEO R50 FIAM-ISEO cylinder | • | • | • | • | • |
| Κύλινδρος AGB SCUDO 9000 30/50 AGB SCUDO 9000 30/50 cylinder | • | • | • | • | • |
| Ηλεκτρονική κλειδαριά FIAM-ISEO X1R FIAM-ISEO X1R electronic lock | - | - | • | • | • |
| Δακτυλικό αποτύπωμα Finger Scanner | - | - | • | • | • |
| Διπλή κλειδαριά (υπηρεσίας) SECUREME (Service) SECUREME double lock | - | - | • | • | • |
| Ηλεκτρική κλειδαριά MOTTURA MOTTURA electric lock | - | - | • | • | • |
| Ηλεκτρικό κυπρί βαρέως τύπου Heavy duty electric strike | • | • | • | • | • |
| Μαγνητικό ασάλι προστασίας με 5 μαγνήτες Magnetic Steel for cylinder protection (include 5 magnets) | • | • | • | • | • |
| Επιπλέον κλείδωμα ασφαλείας (2ο μάνδαλο) Additional Security locking bolt (internal side door latch) | - | - | • | • | • |
| Κατωκάσι & νεροσταλλάκτης αλουμινίου Aluminium waterdrip & Aluminium threshold | • | • | • | • | • |
| Τρίτος Μεντεσές Additional third Hinge | - | - | • | • | • |
| Μηχανισμός επαναφοράς Door closer mechanism | • | • | • | • | • |
| Κασα INOX/Διακοσμητικά INOX INOX Frame/INOX Decoratives | - | - | • | • | • |
| Άνοιγμα τζαμιού 1200x300 Glazing cut 1200x300 | - | - | • | • | • |
| Άνοιγμα τζαμιού 900x500 Glazing cut 900x500 | - | - | • | • | • |
| Ειδικές κατασκευές, σταθερά, φεγγίτης, δίφυλλη, κάγκελα Special structures, fixed side parts, transom window, double leaf door, railings | - | - | • | • | • |

TOMES / SECTIONS

| | A | D | C | |
|-------------------------------------|-----|-------|-------|-------|
| ECONOMY DOOR | | | | |
| Οριζόντια Horintal | 90 | 87,6 | 87,6 | 93,5 |
| | 96 | 93,6 | 93,6 | 99,5 |
| | 102 | 99,6 | 99,6 | 105,5 |
| | a | d | c | |
| Κάθετη Vertical | 205 | 203,8 | 203,8 | 209,7 |
| | 211 | 209,8 | 209,8 | 214,7 |
| | 216 | 214,8 | 214,8 | 219,7 |

| | A | D | C | |
|-------------------------------------|-----|-------|-------|-------|
| S13-16-20XL | | | | |
| Οριζόντια Horintal | 97 | 94,6 | 94,6 | 99,5 |
| | 102 | 99,6 | 99,6 | 105,5 |
| | a | d | c | |
| Κάθετη Vertical | 211 | 209,8 | 209,8 | 214,7 |
| | 216 | 214,8 | 214,8 | 219,7 |

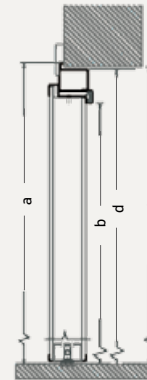
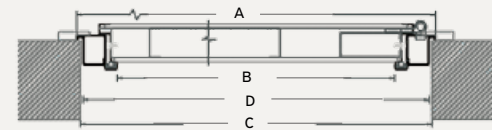

A: ΕΞΩΤΕΡΙΚΗ ΔΙΑΣΤΑΣΗ ΚΑΣΑΣ
A: FRAME EXTERNAL DIMENSION
B: (B=A-154mm) ΚΑΘΑΡΟ ΠΕΡΑΣΜΑ
B: CLEAR PASSAGE (154mm)
D: (D=A-24mm) ΕΞΩΤΕΡΙΚΗ ΔΙΑΣΤΑΣΗ ΠΡΟΚΑΣΑΣ
D: SUBFRAME EXTERNAL DIMENSION
C: ΔΟΜΙΚΟ ΑΝΟΙΓΜΑ
C: STRUCTURAL OPENING

a: ΕΞΩΤΕΡΙΚΗ ΔΙΑΣΤΑΣΗ ΚΑΣΑΣ
a: FRAME EXTERNAL DIMENSION
b: (b=a-82mm) ΚΑΘΑΡΟ ΠΕΡΑΣΜΑ
b: CLEAR PASSAGE (82mm)
d: (d=a-12mm) ΕΞΩΤΕΡΙΚΗ ΔΙΑΣΤΑΣΗ ΠΡΟΚΑΣΑΣ
d: SUBFRAME EXTERNAL DIMENSION
c: ΔΟΜΙΚΟ ΑΝΟΙΓΜΑ
c: STRUCTURAL OPENING

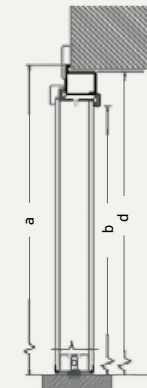
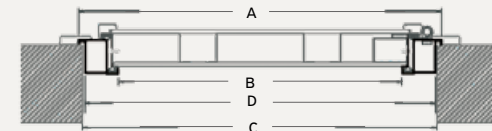

A: ΕΞΩΤΕΡΙΚΗ ΔΙΑΣΤΑΣΗ ΚΑΣΑΣ
A: FRAME EXTERNAL DIMENSION
B: (B=A-154mm) ΚΑΘΑΡΟ ΠΕΡΑΣΜΑ
B: CLEAR PASSAGE (154mm)
D: (D=A-24mm) ΕΞΩΤΕΡΙΚΗ ΔΙΑΣΤΑΣΗ ΠΡΟΚΑΣΑΣ
D: SUBFRAME EXTERNAL DIMENSION
C: ΔΟΜΙΚΟ ΑΝΟΙΓΜΑ
C: STRUCTURAL OPENING

a: ΕΞΩΤΕΡΙΚΗ ΔΙΑΣΤΑΣΗ ΚΑΣΑΣ
a: FRAME EXTERNAL DIMENSION
b: (b=a-82mm) ΚΑΘΑΡΟ ΠΕΡΑΣΜΑ
b: CLEAR PASSAGE (82mm)
d: (d=a-12mm) ΕΞΩΤΕΡΙΚΗ ΔΙΑΣΤΑΣΗ ΠΡΟΚΑΣΑΣ
d: SUBFRAME EXTERNAL DIMENSION
c: ΔΟΜΙΚΟ ΑΝΟΙΓΜΑ
c: STRUCTURAL OPENING

ΟΨΗ ΤΟΠΟΘΕΤΗΣΗΣ ΜΕ ΔΙΑΚΟΣΜΗΤΙΚΑ ΞΥΛΟΥ POSITION VIEW WITH WOOD DECORATIVES

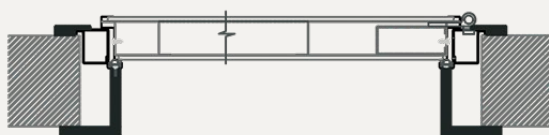

ΟΨΗ ΤΟΠΟΘΕΤΗΣΗΣ ΜΕ ΔΙΑΚΟΣΜΗΤΙΚΑ ΑΛΟΥΜΙΝΙΟΥ POSITION VIEW WITH ALUMINIUM DECORATIVES

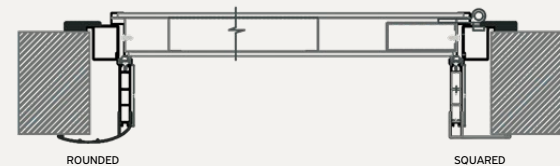

ΤΥΠΟΙ ΘΥΡΩΝ ΑΣΦΑΛΕΙΑΣ / SECURITY DOOR TYPES

| ECONOMY | ECONOMY PLUS | S DOOR 13XL | S DOOR 16XL | S DOOR 20XL |
|---|---|---|---|---|
| | | | | |
| 4 Έμβολα κλειδώματος κεντρικά 4 Central lock steel bolts | 4 Έμβολα κλειδώματος κεντρικά 4 Central lock steel bolts | 4 Έμβολα κλειδώματος κεντρικά 4 Central lock steel bolts | 4 Έμβολα κλειδώματος κεντρικά 4 Central lock steel bolts | 4 Έμβολα κλειδώματος κεντρικά 4 Central lock steel bolts |
| 1 Έμβολο πλευρικό κάτω 1 Lower lateral steel lock bolt | 4 Έμβολα πλευρικά κάτω 4 Lower lateral steel lock bolts | 1 Έμβολο πλευρικό κάτω 1 Lower lateral steel lock bolt | 2 Έμβολα πλευρικά κάτω 2 Lower lateral steel lock bolts | 3 Έμβολα πλευρικά κάτω 3 Lower lateral steel lock bolts |
| 1 Έμβολο κατακόρυφο επάνω 1 Top side steel bolt | 4 Έμβολα πλευρικά επάνω 4 Top side steel bolts | 1 Έμβολο κατακόρυφο επάνω 1 Top side steel bolt | 2 Έμβολα πλευρικά επάνω 2 Top side steel bolts | 3 Έμβολα πλευρικά επάνω 3 Top side steel bolts |
| 1 Έμβολο ελεγχόμενου ανοίγματος / 1 Steel bolt for controlled opening | 1 Έμβολο ελεγχόμενου ανοίγματος / 1 Steel bolt for controlled opening | 1 Έμβολο ελεγχόμενου ανοίγματος / 1 Steel bolt for controlled opening | 1 Έμβολο ελεγχόμενου ανοίγματος / 1 Steel bolt for controlled opening | 1 Έμβολο ελεγχόμενου ανοίγματος / 1 Steel bolt for controlled opening |
| 5 Έμβολα σταθερά πίσω 5 Hinge side fixed steel bolts | 5 Έμβολα σταθερά πίσω 5 Hinge side fixed steel bolts | 5 Έμβολα σταθερά πίσω 5 Hinge side fixed steel bolts | 1 Έμβολο κατακόρυφο επάνω 1 Top side steel bolt 6 Έμβολα σταθερά πίσω 6 Hinge side fixed steel bolts | 1 Έμβολο κατακόρυφο επάνω 1 Top side steel bolt 8 Έμβολα σταθερά πίσω 8 Hinge side fixed steel bolts |

ΤΥΠΟΛΟΓΙΕΣ / TYPOLOGIES

| | | | | |
|-----------------------------------|------------------------------------|--------------------------------------|------------------------|---|
| | | | | |
| μονόφυλλη single sash | +1 πλαινό σταθερό +1 fixed sash | +2 πλαινά σταθερά +2 fixed sashes | + φεγγίτη + transom | +2 πλαινά σταθερά +2 fixed sashes + φεγγίτη + transom |
| | | | | |
| δίφυλλη συμμετρική double sash | δίφυλλη ασύμετρη double sash | +2 πλαινά σταθερά +2 fixed sashes | + φεγγίτη + transom | +2 πλαινά σταθερά +2 fixed sashes + φεγγίτη + transom |

* Κατόπιν παραγγελίας υπάρχει δυνατότητα επιπλέον επιλογών

ΕΞΟΠΛΙΣΜΟΣ & ΕΞΑΡΤΗΜΑΤΑ / EQUIPMENT & ACCESSORIES



ΕΞΑΡΤΗΜΑΤΑ ΙΝΟΧ



ΕΞΑΡΤΗΜΑΤΑ ΜΠΡΟΝΖΕ

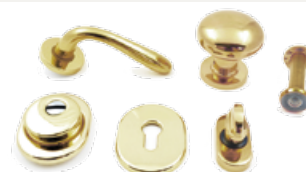

ΕΞΑΡΤΗΜΑΤΑ ΧΡΥΣΑ



ΜΑΓΝΗΤΙΚΟ ΑΤΣΑΛΙ



ΚΥΛΙΝΔΡΟΣ SECUREME



ΚΥΛΙΝΔΡΟΣ R7 ISEO



ΚΥΛΙΝΔΡΟΣ R50 ISEO



ΚΥΛΙΝΔΡΟΣ AGB SCUDO 9000

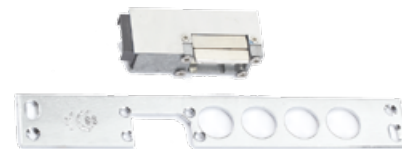

ΗΛΕΚΤΡΙΚΟ ΚΥΡΙΠΙ



ΝΕΡΟΣΤΑΛΑΚΤΗΣ



ΚΑΤΩΚΑΣΙ ΑΛΟΥΜΙΝΙΟΥ



ΙΝΟΧ ΔΙΑΚΟΣΜΗΤΙΚΟ



ΚΛΕΙΔΑΡΙΑ SECUREME
ΜΙΚΡΟ ΚΛΕΔΙ SECURTINA



ΚΛΕΙΔΑΡΙΑ
ΜΙΚΡΟ ΚΛΕΙΔΙ FIAM



ΚΛΕΙΔΑΡΙΑ
ΜΟΤΤΥΡΑ ΗΛΕΚΤΡΙΚΗ



ΚΛΕΙΔΑΡΙΑ
ΗΛΕΚΤΡΟΝΙΚΗ



ΚΑΣΑ ΙΝΟΧ
S13 S16 S20



ΜΑΥΡΗ ΚΑΣΑ
S13 S16 S20

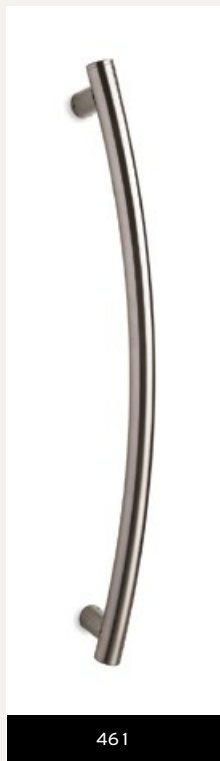
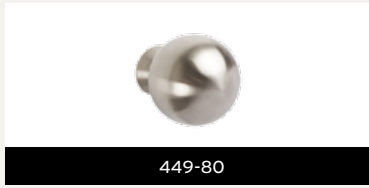
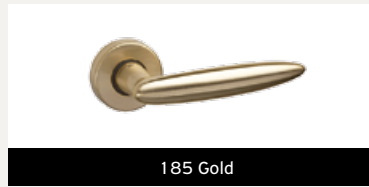
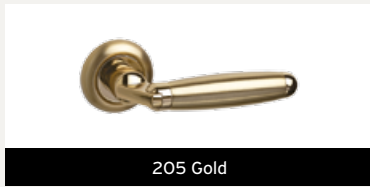

ΧΡΩΜΑΤΟΛΟΓΙΟ / COLORBOOK

ANIGRE / ANIEGRE

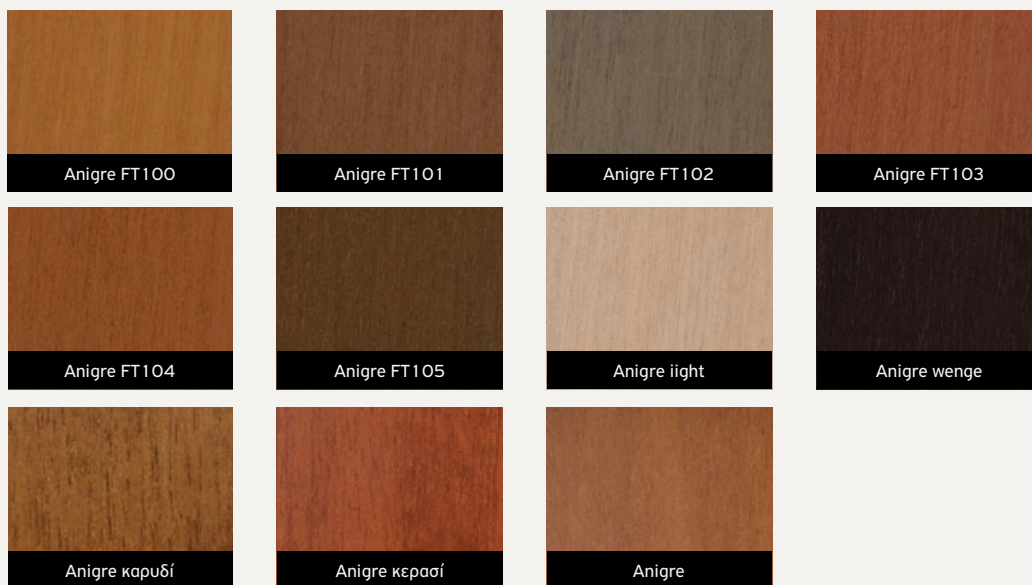

ΔΡΥΣ / ΟΑΚ

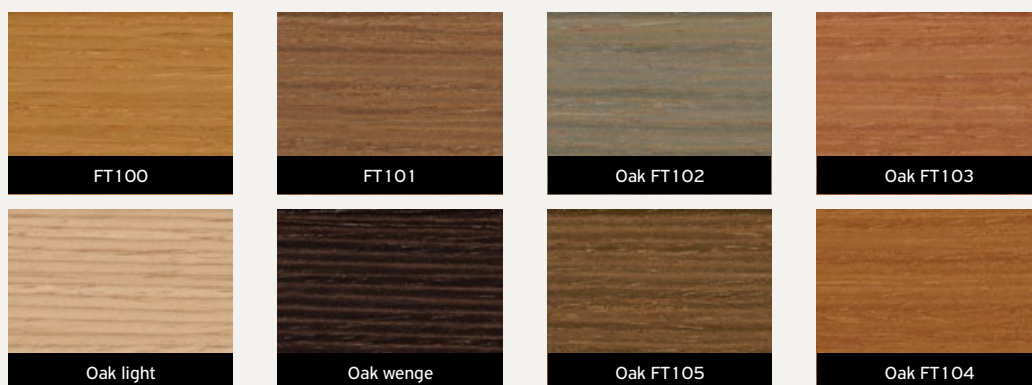

**RAL
ΧΡΩΜΑΤΑ / COLORS**



**EXTRA
DURABLE
POWDER
COATING
COLORS**



**ΣΟΥΜΠΛΙΧΡΩΜΙΑ
ΕΦΕ ΞΥΛΟΥ
SUBLIMATION
WOOD EFFECTS**

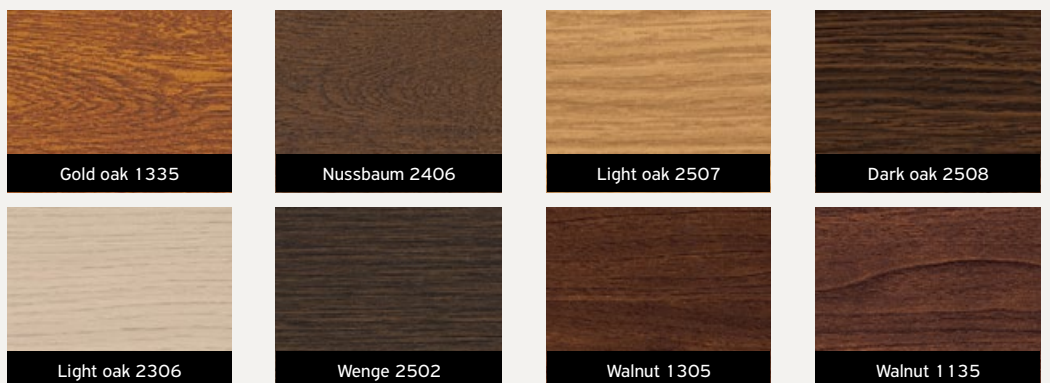

Η ποιότητα των θυρών πιστοποιείται από τα συστήματα διαχείρισης σχεδιασμού και παραγωγής **ISO 9001** και **ISO 14001**, που εφαρμόζει η INTERNO Doors B.U.

Quality is certified in accordance with **ISO 9001** and **ISO 14001** design and production management systems INTERNO Doors B.U By Alumil applies.



- Η Interno Doors B.U. διατηρεί το δικαίωμα να προβεί σε οποιοσδήποτε αλλαγές παραγωγής & βελτίωσης σε οποιοδήποτε χρόνο χωρίς προηγούμενη ενημέρωση.
- Η εταιρεία δεν φέρει ευθύνη για πιθανά τυπογραφικά λάθη.
- Μπορεί να υπάρξουν αποκλίσεις στην αναπαράσταση χρωμάτων & όψεων των υλικών.
- Interno Doors B.U. reserves the right to proceed to any changes and improvements of production at any time without prior notice.
- The company has no responsibility for any tyographical errors that may occur.
- There may be slight color and finishing deviations.

Εργοστάσιο

ΒΙ.ΠΕ. Κιλκίς

611 00, Κιλκίς

T 23410 79 444

F 23410 71 612

E interno@alumil.com

Showroom Θεσσαλονίκης

Ι. Γωγούση 8

564 29, Ν. Ευκαρπία

T 2310 688 439

F 2310 688 439

Showroom Αθηνών

Λεωφόρος Τατοΐου 67

136 71, Αχαρνές - Αθήνα

T 210 800 37 00

F 210 800 38 01

E athina@alumil.com

Headquarters

IND. AREA of Kilkis

611 00 Kilkis, Greece

T +30 23410 79 444

F +30 23410 71 612

E interno@alumil.com

Showroom Thessaloniki

Ι. Gogousi 8

564 29, Ν. Eukarpia

T 2310 688 439

F 2310 688 439

Showroom Athens

Tatoiou Avenue 67

136 71, Acharnes - Athens

T 210 800 37 00

F 210 800 38 01

E athina@alumil.com



**OPEN
THE
RIGHT
ONE**

www.internodoors.com



www.internodoors.com



INTERNO
DOORS BY ALUMIL